



PVI 60KW

PVI 82KW

PVI 95KW

INSTALLATION AND OPERATION MANUAL

**Commercial, Grid-Tied Photovoltaic
Inverters**

© 2009, Solectria Renewables LLC

Subject to Change



IMPORTANT SAFETY INSTRUCTIONS

In this manual “Inverter” or “Inverters” refers to the inverter models: PVI 60KW, PVI 82KW and PVI 95KW unless one of the specific models is noted.

This manual contains important instructions that shall be followed during installation and maintenance of the PVI 60KW, PVI 82KW AND PVI 95KW Inverter.

To reduce the risk of electrical shock, and to ensure the safe installation and operation of the inverter, the following safety symbols are used to indicate dangerous conditions and important safety instructions.



WARNING: This indicates a fact or feature very important for the safety of the user and/or which can cause serious hardware damage if not applied appropriately.

Use extreme caution when performing this task.

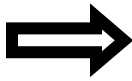

NOTE: This indicates a feature that is important either for optimal and efficient use or optimal system operation.



EXAMPLE: This indicates an example.

SAVE THESE INSTRUCTIONS

IMPORTANT SAFETY INSTRUCTIONS

- All electrical installations shall be performed in accordance with the local and national electrical codes ANSI/NFPA 70.
- The Inverter contains no user serviceable parts. Please contact Solectria Renewables or a Solectria Renewables authorized system installer for maintenance. (Appendix C for Solectria Renewables contact information and authorized system installers.)
- Before installing or using the Inverter, please read all instructions and caution markings in this manual and on the Inverter unit as well as the PV modules.
- Connection of the Inverter to the electric utility grid must be done after receiving prior approval from the utility company and must only be performed by qualified personnel.
- Completely cover the surface of all PV-arrays with opaque (dark) material before wiring them. PV arrays produce electrical energy when exposed to light and could create a hazardous condition.
- The inverter enclosure and disconnects must be locked (requiring a tool or key for access) for protection against risk of injury to persons. The enclosure includes a lockable handle and comes with a key. Keep the key in a safe location in case access to the cabinet is needed. (A replacement for a lost key can be obtained from Solectria Renewables.)

SAVE THESE INSTRUCTIONS

Table of Contents

1	Introduction.....	5
2	Installation.....	6
	2.1 Checking for Shipping Damage.....	6
	2.2 Inverter Mounting.....	6
	2.3 Electrical Connection and Connection to Electrical Utility Grid and Surge/Lightning Protection.	10
3	Commissioning the Inverter PV System	17
4	Power, GFDI and Error LED Indicators and LCD Display.....	19
	4.1 Power, GFDI and Error LED Indicators.....	19
	4.2 LCD Display.....	22
5	Troubleshooting & Opening the Main Enclosure.....	24
6	Product Warranty and RMA Policy.....	29
7	Technical Data.....	34
	Pin Assignment for RS-232 and RS-485 communication connector.....	39
8	Appendices.....	40
	Appendix A Datasheet: PVI 60KW, PVI 82KW, PVI 95KW.....	40
	Appendix B String Sizing Examples.....	40
	Appendix C Contact Information, Dealers and Installers	41
	Appendix D UL1741 Listing Letter	42

1 Introduction

The PVI 60KW, PVI 82KW and PVI 95KW are commercial, 3-phase grid-tied PV inverters designed to be inter-connected to the electric utility grid. With this manual the Inverters can be installed and operated safely. This installation guide is used as reference for the commissioning and as a guideline on how to use the inverter most effectively.

Feeding power into the grid involves conversion of the DC-voltage from the PV-array to grid compatible AC-voltage by “inverting” DC to AC. This unit feeds power into a standard 480VAC, 3-phase commercial, industrial or institutional facility’s electrical system which is connected to the electrical grid. (208VAC and 240VAC versions are also available, and custom 380VAC versions – request different manual that covers 380VAC versions.)

If the PV system and inverter are providing the same amount of electrical power that the facility is using then no power is taken from or fed into the utility grid. If the facility is using more power than the PV system is providing, then the utility grid provides the balance of power. If the facility is using less power than the PV system is generating, then the excess is fed into the utility grid.

Be sure to look into local regulations regarding Net Metering/inter-connection in your local area. Note that some utilities need to change their revenue kWh meter for proper Net metering measurement and billing.

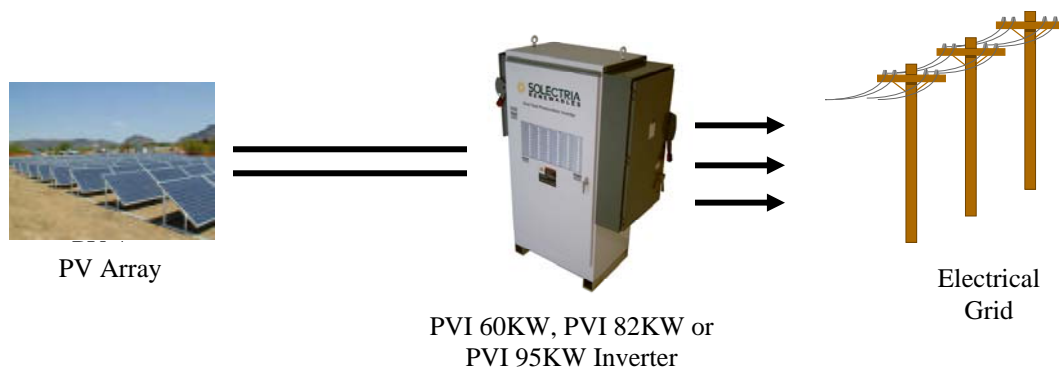

Fig. 1 Grid tied inverter application

2 Installation



WARNING: Before installing the Inverter, read all instructions and caution markings in this manual and on the Inverter as well as on the photovoltaic modules.



WARNING: Electrical installation shall be performed in accordance with all local electrical codes and the National Electrical Code (NEC), ANSI/NFPA 70.



WARNING: Connecting the Inverter to the electric utility grid must only be done after receiving prior approval from the utility company and installation completed only by qualified personnel/licensed electrician(s).

2.1 Checking for Shipping Damage

The Inverter is thoroughly checked and tested rigorously before it is shipped. Even though it is bolted onto a rugged, oversized pallet or in a crate for delivery, the inverter can be damaged during shipping by poor handling, trucking or transfer station activity.

Please inspect the inverter thoroughly after it is delivered. If any damage is seen please immediately notify the shipping company to make a claim. If there is any question about potential shipping damage, contact Solectria Renewables. A photo of the damage may be helpful.

Do not accept the unit if it is visibly damaged or if you note visible damage when signing shipping company receipt. Note damage on shipping papers with the truck driver! Report damage immediately to the shipping company. Do not remove the unit from pallet/packaging. If it is determined that the unit must be returned, an RMA# must be obtained from Solectria Renewables.

2.2 Inverter Mounting

Removing inverter from pallet and moving inverter:

- Use a forklift or fork attachment on other equipment if lifting from the bottom. The equipment must be rated for at least 2000-2500lb since the inverter is about 1600-1750 lb. The forks should be set at a 27-28" outside spacing so they fit just in between the inverter's 4 x 4" aluminum tube feet. Before lifting, make sure forks are against the inside edges of both feet.
- Once off the pallet a pallet jack can also be used to roll the unit on a floor. Use a 27" wide jack.
- Alternatively, the inverter can be lifted using the lifting eyes on the top. If using this lifting method, lift with vertical chains and hooks connected to a proper lifting device. Do not lift with an "A" chain between the two eyes as this could bend the inverter's roof.

The Inverter is comprised of a rainproof industrial enclosure containing electrical and electronic components including a transformer, filters, a contactor (for zero night-time power consumption), fuses, a sealed IP62 power & control electronic inverter unit (DMGI660) and AC and DC disconnects mounted on the sides of the main enclosure.

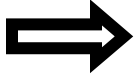

NOTE: If the Inverter is mounted outside, please make sure the enclosure and disconnect doors remains closed in case of rain during the installation process. (Leaving these doors open voids the warranty.) Since the AC and DC connections are made in the side-mounted disconnects only, there is no need to open the main enclosure during hook-up. The disconnect doors should be closed in case of rain.

Notes regarding mounting and placement of the inverter

Criteria for device mounting:

- Because the power electronics is in an IP62 sealed enclosure within the rainproof main enclosure, the inverter can be mounted outdoors.
- The maximum life for the inverter can be achieved by mounting the unit in a clean, dry and cool location even given the unit's robust construction, rainproof design and powerful cooling system.
- For optimal electrical efficiency, use the shortest possible AC and DC cables and use the maximum allowable cable size.
- Avoid installation in close proximity to people or animals, as there is a small amount of audible high-frequency switching noise.
- Install the inverter in an accessible location following NEC codes for enclosure and disconnect door clearances and proximity to other equipment. (See mounting diagram, Fig. 2.2)
- For optimal inverter life and performance, do not mount the inverter in direct sunlight, especially in hot climates, although the inverter is designed to function at full power continuously in up to 50°C ambient temperatures. In hot climates if the unit must be mounted in direct sunlight a metal sun-shield is recommended. It is recommended that the inverter is mounted on the north side of buildings or on the north side of a PV array (which can provide some shade). It is also recommended to face to door north or east if possible.



CAUTION: Please follow these guidelines:

- The inverter weighs about 1600-1750 lbs. Be sure to verify load capacity of floor, roof or concrete pad mounting area (recommended).
- The ambient temperature must be between -25°C and +50°C for full power, continuous operation. (The inverter will automatically reduce power or may shut down to protect itself if ambient air temperature rises above 50°C.).
- The inverter enclosure and disconnects must be locked (requiring a tool or key for access) for protection against risk of injury to persons. The enclosure includes a lockable handle and comes

with a key. Keep the key in a safe location in case access to the cabinet is needed. (A replacement for a lost key can be obtained from Solectria Renewables.)

- The National Electrical Code (NEC) requires that the inverter be connected to a dedicated circuit and no other outlets or device may be connected to this circuit. See NEC Section 690-64(b)(1). The NEC also imposes limitations on the size of the inverter and the manner in which it is connected to the utility grid. See NEC Section 690-64(b)(2).
- The cooling air exhausts at the bottom of the unit. Nothing should block the 4” clear space under the enclosure defined by the 4” tall mounting feet.
- A minimum distance of 12 inches (300mm) must be clear above the inverter for ventilation.
- The inverter must be mounted with *at least* a 4” open space behind it. Air should be able to flow up behind the unit from below it to above it.
- If you are installing the inverter in a utility vault or electrical closet, the air circulation must be sufficient for heat dissipation – provide external ventilation, to maintain an ambient condition of less than 50°C. The ambient temperature should be kept as low as possible at all times.
- Correct mounting position for the inverter is vertical with the mounting feet on the floor. This diagram shows the basic inverter dimensions:

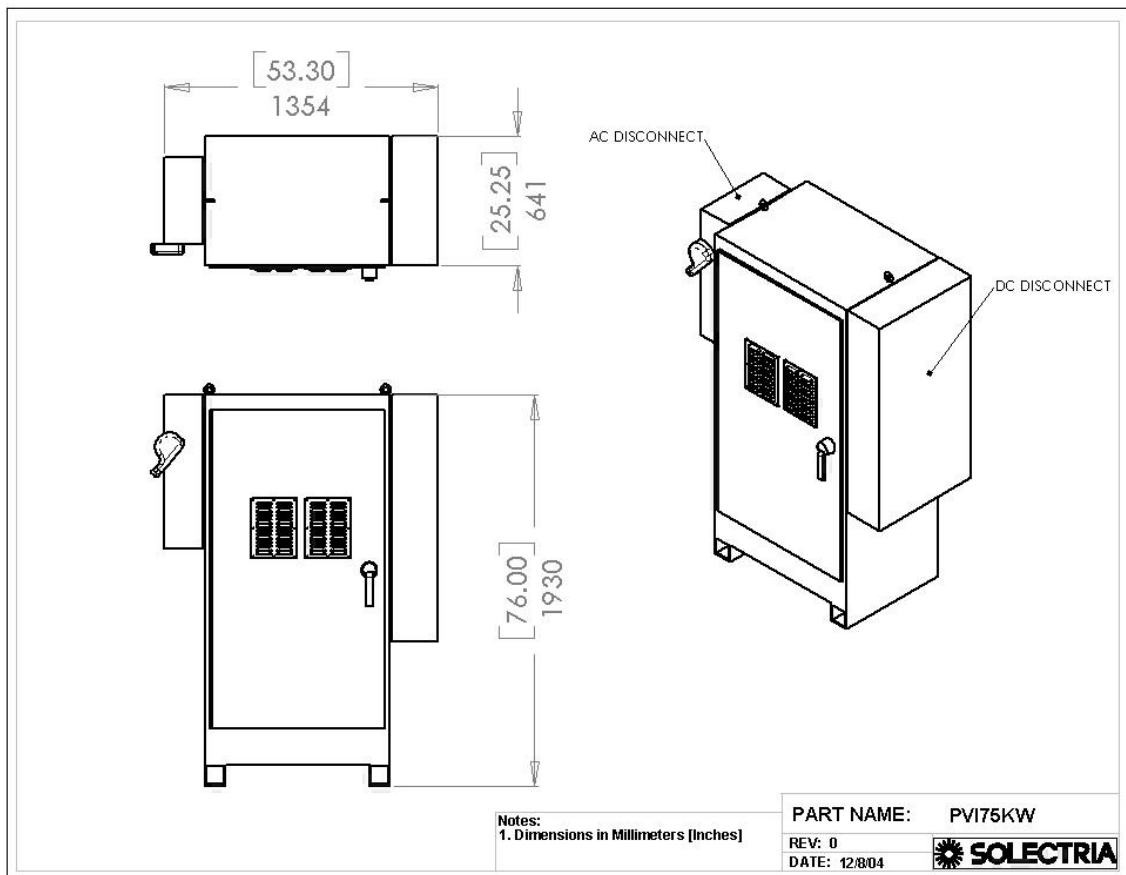
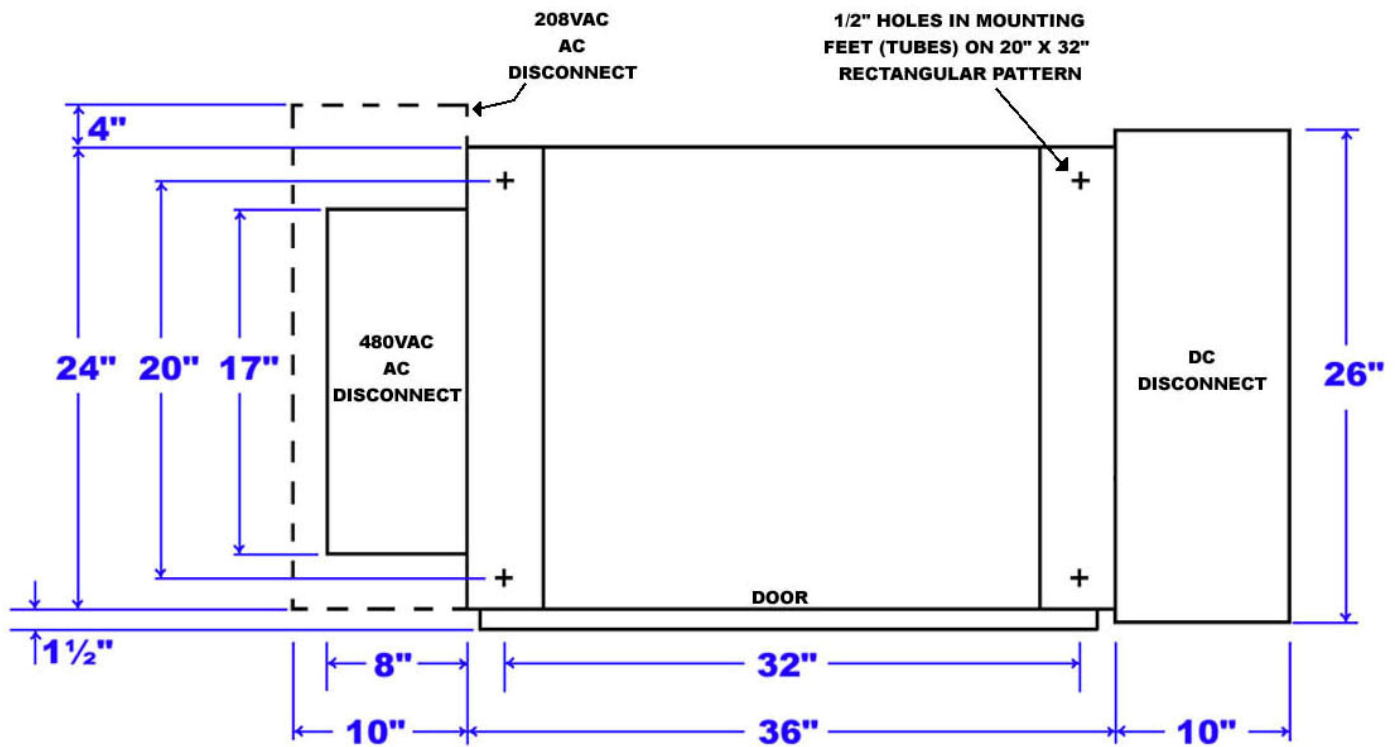

Fig. 2.1 Dimensions to mount the inverter (480VAC version shown in diagram).



VIEW FROM TOP OF INVERTER

Fig. 2.2 PVI 60KW, PVI 82KW AND PVI 95KW Mounting Hole Diagram

Mounting Details

Using the mounting diagram Fig. 2.2, choose whether floor/roof or concrete pad mounting will be used. The inverter includes mounting feet with 4 holes (1/2", 12mm diameter) on a 20" x 32" rectangular pattern for attaching the inverter. Note that these 4 mounting holes are 2" inside each corner of the main inverter enclosure dimensions which are 24" x 36".

It is recommended to use four hot dip galvanized grade 5 or 8 steel bolts or stainless steel bolts. The correct bolt size is 3/8" (10mm) diameter. Use a heavy lock washer and flat washer with each bolt. After mounting is completed, remove shipping aids from front cowl and inside unit.



WARNING: Severe injury or death could occur if the inverter mounting fails and the unit tips over or falls on a person.



NOTE: The 1630-1824 lb. weight of the inverter will exert this added load to floor, roof or pad where mounted. Be sure to verify proper load capacity of mounting surface.

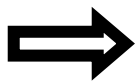

NOTE: If the roof/floor mounting only uses the inverter's mounting feet, be sure you use all 4 available foot mount bolt positions.



NOTE: Once mounting is completed, remove shipping aids from the inverter

- Packing material under cowl on front door
- Packing material between large power cables and contactor inside upper portion of the inverter.

2.3 Electrical Connection and Connection To Electrical Utility Grid

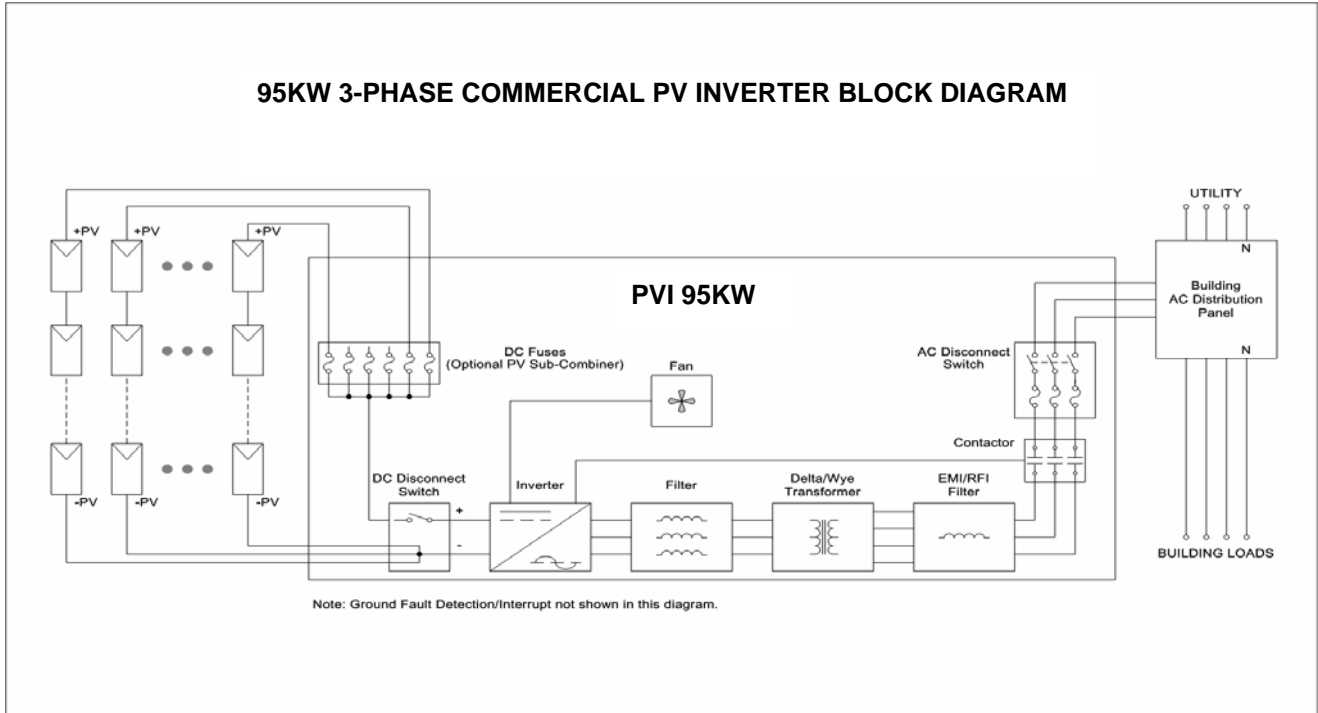

Fig. 3 Simplified electrical connection diagram for the PVI 60KW, PVI 82KW and PVI 95KW



NOTE: For versions of the inverter which do not have fuses in the AC disconnect (such as the standard 208VAC versions or a version with a specially requested AC disconnect), refer to NEC 240.21 regarding the “tap” rule and requirements for over-current protection of output wiring based on distance to dedicated over-current protection fuse of dedicated circuit breaker protection within specified distances.

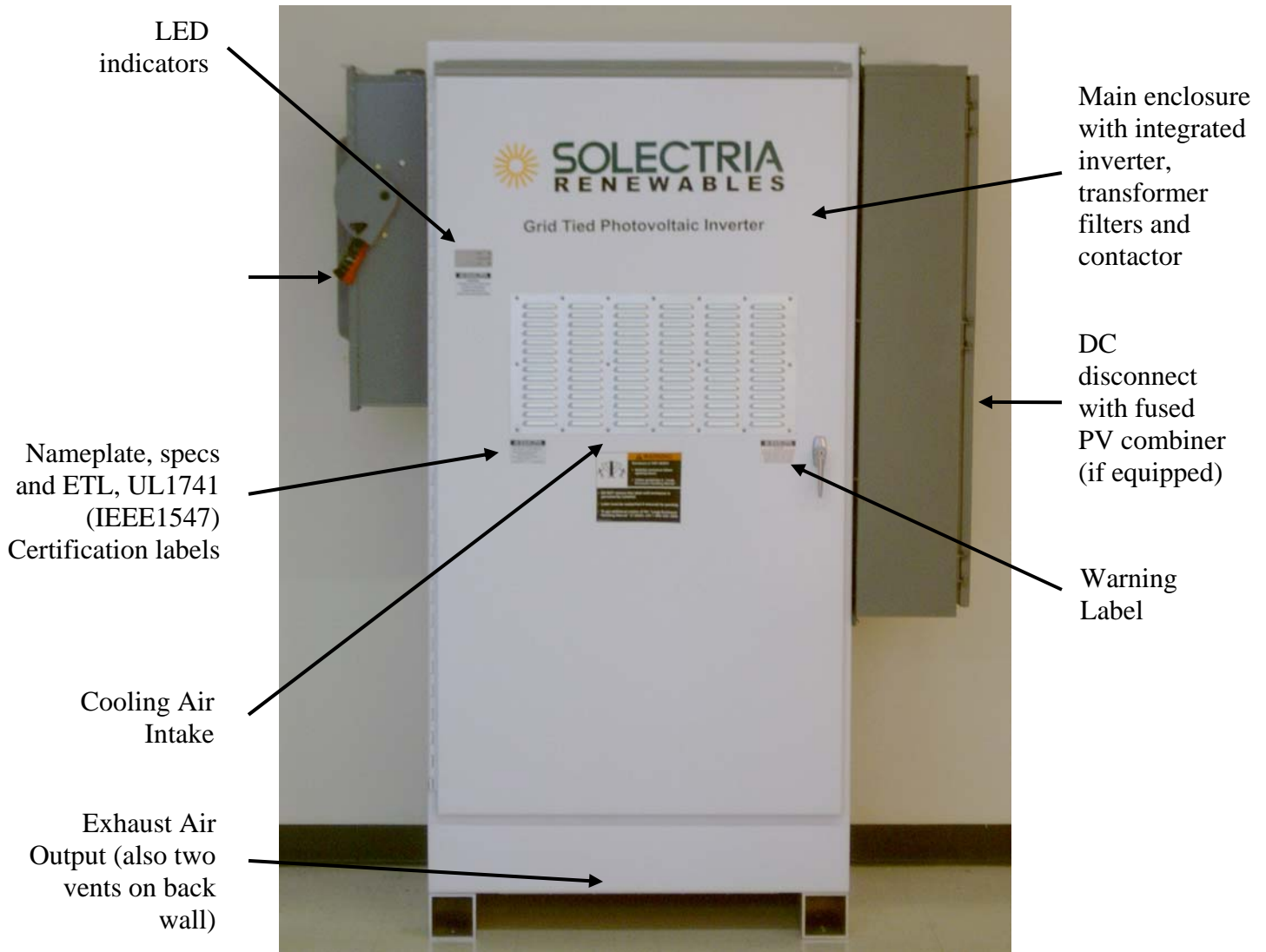

Fig. 4 “Integrated Inverter Package” (480VAC unit shown)



WARNING: All electrical installations shall be done in accordance with all local electrical codes and the National Electrical Code (NEC), ANSI/NFPA 70. Only make AC and DC connections directly to AC and DC disconnects.

The negative DC, Photovoltaic connection is grounded within the inverter through the ground fault detection and interrupt circuit (GFDI). The PV negative should not be grounded at any other point in the system. The PV positive must never be grounded at any time.

When conduit hubs are used on the AC and DC disconnect boxes in an outdoor or wet location, rain-tight or wet location hubs that comply with the requirements in the Standard For Fittings For Conduit and Outlet Boxes, UL514B, are to be used.

For AC, 3-phase wiring, first verify proper phase sequence, and then use 1 AWG, (recommended for the 480VAC version) minimum 90°C (194°F), copper wire for connection with the inverter’s 3-phase AC disconnect. Disconnect terminals listed

for 75°C. See NEC 310.10 regarding temperature ratings of wire. (250KCMIL wire is the recommended minimum wire size for the 208VAC version.) Torque terminal screws to 275 in-lb on the 480VAC version and 340 in-lbs on the 208VAC version. Voltage drop and other considerations may dictate that larger wire sizes be used. A maximum of 250KCMIL copper conductor wire on all 480VAC versions as well as 60kW unfused 208VAC version and 750KCMIL for the fused 60kW, 208VAC and both fused and unfused 82 and 95kW 208VAC versions. Up to a 1/0 AWG copper ground conductor can be used for both the 480VAC and 208VAC versions (AC equipment ground, torque to 100in-lb). An additional AC ground lug is provided of the same size in the 480VAC versions and a larger size in the 208VAC versions which fits from 6AWG to 250KCM (torque to 275in-lb). Verify that any wire size choices meet NEC requirements. Parallel wiring for current-carrying conductors may conform to code for AC (and/or DC) side of your wiring to the inverter.

For DC wiring, if the inverter is not equipped with an integrated fused PV sub-combiner, a minimum conductor size of 4/0, 90°C (194°F) copper wire must be used for the DC (PV) positive and negative conductors. (Disconnect terminals listed for 75°C. See NEC 310.10 regarding temperature ratings of wire.) A maximum of 750KCMIL copper wire can be used for positive & negative conductors (or two 300KCMIL wires for each positive and negative). Two lugs are provided for DC equipment ground and grounding electrode conductor, a 6AWG-1/0 and 6AWG-250KCMIL lug in the DC (PV) disconnect. Minimum recommended DC equipment ground wire is 3AWG, however consult local codes. A 250KCM maximum DC equipment ground can be connected to the standard lug if NEC and local code allows it for your installation and configuration. Torque the (+) terminal screws to 550 in-lbs, torque the (-) terminal screws to 340 in-lbs and the 6AWG-1/0 ground lug to 100 in-lbs. A larger ground lug for 6AWG to 250KCM (torque to 275in-lb) is also provided in the same location and this is useful if the PV conductors are upsized and it is necessary to upsize the DC equipment ground conductor or the grounding electrode conductor (see Grounding Electrode Conductor Section below).

Lightning and Surge Protection:

The inverter is designed with certain protections against surges in voltage including certification to ANSI/IEEE 62.41/62.42 (as required in the NY SIR), however added protection and solid grounding provisions are important for best protection against utility surges and surges created by indirect lightning strikes.

The installation of a Delta lightning surge arrester or other UL listed arrester of the correct specification is recommended on both the DC and AC sides of inverter. This can be installed on the outside of the DC disconnect and wired using the manufacturer's directions. This device gives important added protection from indirect lightning strikes and resulting surges that provide protection beyond the inverter's UL1741 requirements. It is suggested to drive a ground rod specifically for the PV array. It is also a very good idea to have the lightning protection system of the building checked and upgraded if needed before the PV system is installed. (Are there air conductors/lightning rods along the roof-line of the building well above the PV array? Do you see a copper ground wire running from the air conductors to a ground rod?) These added protections are especially important for area prone to thunder storms and possible nearby lightning strikes. Although these added

precautions will not guarantee that there will be *no* damage from lightning, they can help prevent or limit potential damage.

Grounding Electrode Conductor (GEC):

As with all PV systems, a Grounding Electrode Conductor must be installed per UL690.47 (and 250.166). This conductor should be sized according to these NEC requirements. This conductor should be terminated on the ground bar in the DC disconnect. If required, an additional lug of the appropriate size for the grounding electrode conductor can be added in the DC disconnect and bonded to the existing ground bar bolt in the disconnect or mounted elsewhere on the ground plate to which the existing ground bar is attached. If the grounding electrode conductor is required to be larger than 250KCMIL (the maximum size wire for the ground lug provided), then the grounding electrode conductor should enter the lower section of the main Inverter enclosure through a rain-tight conduit fitting and the conductor should be terminated under the left side of the large aluminum shelf above the transformer on the provided star/bonding point stud. This stud comes out of a (1/4-20) PEM nut at the left end of the aluminum angle support under the shelf. You should use an appropriate lug for the conductor and corrosion-prevention grease between lug and aluminum bracket. (If a longer stud is needed, replace with a longer 1/4-20 bolt above which must be threaded all the way up to the bolt head.)



WARNING: The wiring connections of the inverter to the DC-voltage from the PV strings and the AC-voltage of the utility must be performed with the AC and DC disconnects off, building AC source circuit panel/breaker off and the PV module strings disconnected (or covered up).

- Connect the building 3-phase conductors and AC equipment ground at AC disconnect “LINE” terminals (L1, L2, L3) and ground bar. Phase sequence **MUST** be correct (clockwise!). Must be checked with a phase rotation meter.
- Connect the PV strings to the DC disconnect enclosure positive (switched) terminal (+) and negative terminal. Connect the DC equipment ground to the ground bar. (If positive grounded PV array, wire accordingly)
- Connect PV modules, strings, combiners or uncover them.
- Verify proper AC and DC voltages and DC polarity. Verify proper AC phasing! The connection of the grid to the inverter must follow the L1/A, L2/B and L3/C **clockwise** order. Test with a phase direction tester or a scope-meter. Extech, Fieldpiece, Fluke and UEi make phase rotation meters. Do not assume existing color code or building wiring is correct! **NOTE:** It may be necessary to swap the phase A&B wires connecting the building circuit to the inverter’s disconnect if building phasing or wiring anywhere between utility and the inverter is not in proper phase sequence. Incorrect phase sequence at the 3-phase AC connection in the AC disconnect can damage the inverter. Turn on the inverter by switching building/utility 3-phase breakers ON then turning on inverter’s AC disconnect followed by DC disconnect.

To disconnect the inverter from the building/utility grid, turn off the DC disconnect, then the AC disconnect. Turn off the AC 3-phase building/utility breaker if needed.

Connection to dedicated 480V AC, 3-phase circuit, 125A circuit for PVI 60KW or 150A for the PVI 82KW and PVI 95KW, 2 AWG to 250KCMIL copper wire. Torque to 275 in-lb. (Shown without plastic safety cover). If 208V AC version, circuit should be 200-250A for PVI 60KW (1/0-250KCMIL for unfused, up to 750KCMIL for fused) and 300A for PVI 82KW and 350A for PVI 95KW (250-750KCMIL all 82-95kW versions). Phase sequence MUST be wired correctly and clockwise rotation verified.

125A or 150A Fuses (for 480V AC version), 600V, FRS-R-125 or -150 (If 208V AC version, no fuses. Fused disconnect can be ordered as an option.)

AC Equipment (2) Ground connections 6AWG to 1/0AWG copper wire (100in-lb), For 208VAC version, second larger lug 6AWG-250KCM (275in-lb)

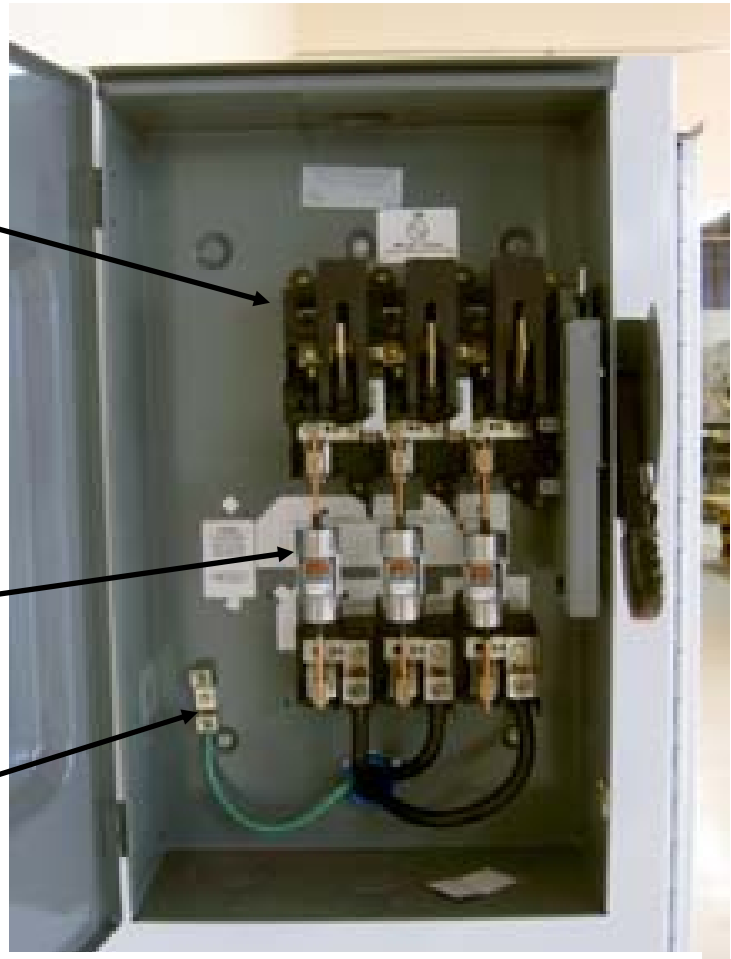

Fig. 5 AC disconnect (480VAC inverter version shown)

PV equip ground & GEC connections, 6AWG-1/0 (100in-lb) and 6AWG-250KCMIL (275in-lb) copper wire (larger lug)

PV negative (-) connections 4/0 - 750KCMIL (1) copper wire (or 2 up to 300KCMIL each); torque to 340 in-lbs. Tape wires white (grounded). (This is the positive terminal in units with the positive grounded option.)



Fig. 6 DC disconnect without a Fused PV Sub-combiner option.

PV positive (+) connections 4/0 - 750KCMIL (1) copper wire (or 2 wires up to 300KCMIL each) torque to 550 in-lb. (This is the negative terminal in units with the positive grounded option.)

Customer/installer conductors not shown.



WARNING: Fuses in the inverter's AC disconnect must only be replaced with the same type fuses installed.

Inverter Model	AC Voltage	Fuse Type
60kW	480VAC	600VAC RK5, FRS-R-125 125A
82kW and 95kW	480VAC	600VAC RK5, FRS-R-150 150A
60kW	208VAC	250A RK5 FRS fuses or breaker
82kW	208VAC	300A RK5 FRS fuses or breaker
95kW	208VAC	350A RK5 FRS fuses or breaker



WARNING: If inverter is equipped with the fused PV sub-combiner, fuses in DC disconnect must only be replaced with 600VDC rated fuses of the same type. Always refer to PV module and combiner fuse ratings and specification before selecting or replacing fuses.

Connection Wiring To Electrical Utility Grid

The PVI 60KW, PVI 82KW or PVI 95KW must be connected to the grid with 3 conductors and an AC equipment-grounding conductor.

Inverter Model	AC Voltage	Breaker required
60kW	480VAC	125A
82kW and 95kW	480VAC	150A
60kW	208VAC	250A
82kW	208VAC	300A
95kW	208VAC	350A

The grid impedance value at the connection point should be as low as possible to avoid an increase of the AC-voltage to non-permissible values while the inverter feeds to the grid. Minimizing wiring impedance also results in higher system efficiency.



EXAMPLE: The impedance is the sum of the electricity grid impedance at building distribution and all impedance values of conductors and connections.

Single conductor impedance values are:

- Approximately 0.04 Ohm for 250 feet (76.2 m) 2 AWG conductors
- Approximately 0.025 Ohm for 250 feet (76.2 m) 1/0 AWG conductors

- Approximately 0.012 Ohm for 250 feet (76.2 m) 4/0 AWG conductors
- Conductor impedance of < 0.025 Ohm is recommended

It is recommended that the total impedance phase to phase of the grid plus the interconnecting AC conductors should be less than 0.035 Ohm for the 480VAC versions and about ½ this, or 0.015 Ohm for the 208VAC versions.

Connection of the PV-panels to the DC disconnect enclosure with or without integrated fused PV sub-combiner



WARNING: Follow PV module and combiner manufacturer directions. PV-arrays produce electrical energy when exposed to light and could create a hazardous condition. (One method used to assure safety from shock is to completely cover the surface of all PV-arrays with opaque (dark) material before wiring them.)

Depending on the type of PV-modules used it is possible to use different numbers of parallel strings. (Appendix B shows some example PV string sizing tables.)



WARNING: Before connecting the connectors of the PV-panel to the DC disconnect enclosure fused PV sub-combiner (if equipped) or + and – terminal block if not equipped with combiner check the correct polarity and admissible PV-panel voltage between the + and the - cable connectors of the PV panel.

The PV-panel open circuit voltage must be below 600V DC ($V_{pv} < 600V$ DC) under all conditions as per NEC 690-7. Please read the Technical Info section and see PV string sizing table in Appendix B.

Inverter with optional fused PV sub-combiner in DC disconnect enclosure:



There are up to 8 fuse blocks for up to 8 PV combiner connections (from 40-250A fuses). The positive (+) wire from each string is connected to each fuse block bottom screw terminal. There are also up to 8 negative positions to be used for negative (-) connections on the negative (-) terminal block. Conductors from array field combiners to inverter sub-combiner fuse holder terminals must be sized according to the paralleled string group (combined) current ratings with appropriate multipliers/de-rating per NEC and must be taped white.

Inverter without fused PV sub-combiner in the DC disconnect enclosure:

There are positive and negative terminals for connection of a combined PV power feed from a customer-provided external fused PV combiner system.



WARNING: A fused, correctly rated PV combiner and in some cases, sub-combiner, must be used with this version of the inverter.



WARNING: Even when in the off position, the DC disconnect will remain live on the PV side (“line”) when the PV modules are in daylight. The inverter (“load”) side of the disconnect will also remain live after the disconnect has been shut off until 60 seconds after the LEDs turn off, as electrolytic DC bus capacitors in the inverter discharge.

Inverters connected in conjunction with emergency back-up generators:

Please follow all applicable NEC and local codes.

The inverters meet and are certified to all UL1741 and IEEE1547 requirements.

There are two methods to connect inverter or inverters to a grid-connected building that includes an emergency generator: (note that these are only thoughts on this subject – consult your inspector)

1.) Inverter(s) on the grid-side of the transfer switch that disconnect the building when the utility goes off. With this method, when the grid goes off, the inverters go off, the transfer switch disconnects the building from the PV inverters and grid. Then the generator starts and runs for the duration of power outage. In this case, the inverter is on the grid-side of the transfer switch and the inverters remain off the entire time until the grid returns.

2.) Inverter(s) on the load/building side of the transfer switch that disconnect the building when the utility goes off. With this method when the grid goes off, the inverters go off, the transfer switch disconnects the building with inverter(s) from the grid and the generator starts, the inverter(s) will attempt to start in parallel with the building/load/generator. With a large size generator and load, the inverter will most likely come back on and run well. If at any time the voltage or frequency of the system goes outside of the limits set in UL1741, then the inverter will go off and re-start 5 minutes later. This trial and restart sequence should not cause any trouble for the building, generator or inverter, however, if the PV system has close to or more than the power level of the generator and/or loads at any time, it is not recommended to use this hook up configuration (with the inverter on the building/load side of the transfer switch)

3 Commissioning the Inverter PV System

The inverter is mounted, all connections are made and you are ready to power it up.

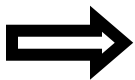

NOTE: Make sure all tools; parts, etc. are removed from the vicinity of the inverter before turning on.



WARNING: Make a final check for correctness of all AC and DC wiring to the inverter and in the system.

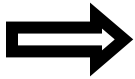

NOTE: With the PV modules connected and inverter disconnects still off, it is a good final precaution to check PV voltage and polarity once more simply by carefully using a 600V, DC rated digital volt meter and probing the positive (+) and negative (-) PV connections in the disconnect enclosure. Verify clockwise AC phase rotation for L1, L2, L3 using a phase rotation meter.

Turning on the inverter:

- Turn on the dedicated 3-phase (dedicated) circuit breaker on the building electrical panel.
- Verify the proper CLOCKWISE phase sequence at the “line” side terminals (top) of the AC disconnect. Do NOT turn on until clockwise phase sequence has been verified!
- Turn on the Inverter’s 3-phase AC disconnect.
- If equipped with Fat Spaniel Inverter-Direct monitoring option, refer to Fat Spaniel PV2Web Installation Manual for gateway startup sequence before turning on inverter’s DC disconnect.
- Turn on the Inverter’s DC disconnect.
- Watch the LED indicators for initialization (all three LEDs on), then slow blinking green LED followed by faster blinking green LED.
- Listen for contactor clunk (inverter on-line).
- Listen for slight 60 Hz hum (transformer on-line).
- Following the blinking green LED and high frequency switching sound you should see a solid green LED (inverter on-line and beginning to feed power into 3-phase circuit). This confirms that the inverter is operating normally.

Operation:

The control electronics and DSP will be active as soon as DC (PV) voltage reaches 300V DC. The inverter will go on-line with the utility/building 3-phase grid when the DC voltage first exceeds 400V DC (strike voltage). Next, the inverter will load the array, bringing the DC voltage down from 400V DC to not less than 325V DC.

Once there is enough PV power at 325V DC to back feed 3-phase AC power switching will automatically feed power to the grid.

Because the inverter goes completely off line at night or in dark conditions when no power can be produced, there are no idling losses, adding 1-2% additional energy production annually over an inverter design that remains on all the time.

Operating states, GFDI status and error indications shown by the LED indicators, which are described in chapter 4, “Power, GFDI and Error LED Indicators”.

4 Power, GFDI and Error LED Indicators and LCD Display

The inverter operates automatically without the need for user interaction or maintenance.

The Inverter automatically starts back feeding 3-phase AC power into the grid every morning as the sun rises, as soon as sufficient DC voltage and PV power is available. The inverter DSP runs through various checks before going online with the grid and feeding power into the grid.

4.1 Power, GFDI and Error LED Indicators

The LED indicators mounted on the right-hand side of the enclosure just above the DC disconnect give the installer and user a good, quick look at what state the inverter is in and if it is operating normally.

GREEN – indicates “power”, the unit is powered up and/or feeding power to the grid

RED – “ERROR” or “FAULT”, the inverter is not providing power due to an error or fault

RED & YELLOW – together indicate that a ground fault has been detected and it must be located before the inverter will function. Check GFDI fuse if RED LED remains as solid.





If the GFDI fuse is blown, see “Opening the Main Enclosure” section and Fig. 8, “Description and Location of Components”. Follow these instructions carefully (disconnecting AC & DC power) and locate, check and replace the GFDI fuse with a 2A midget fuse 600V DC rated such as Solectria Renewables P/N KLKD002, or Bussmann P/N KLKD-2.

























































Fig. 7 Front view of inverter showing LED indicators, LCD display and ground fault warning label

Description of LED symbols used to indicate LED status in this manual

○ LED Off

-  LED flashing (25% on, 75% off)
-  LED on once per second
-  LED on two times per second
-  LED on with short interruptions (75% on, 25% off)
-  LED on

LED indicator		Operating condition	Description
green: yellow: red:		standby (night)	input voltage < 125 VDC
green: yellow: red:		initialization	unit is being initialized
green: yellow: red:		stop	Input voltage low < 325V (400V @ startup)
green: yellow: red:		stop	input voltage high > 570V (600 VDC is the maximum allowable PV open circuit voltage)
green: yellow: red:		waiting for stronger sun	available DC power is too low
green: yellow: red:		waiting, checking grid	presence of valid grid conditions Is being checked
green: yellow: red:		starting / synchronizing	-starting transformer -synchronization to grid -closing contactor
green: yellow: red:		waiting for AC disconnect/breaker to be closed	grid voltage Is absent
green: yellow: red:		AC fuse blown (one phase)	One AC power fuse blown Or one v-sense fuse blown Or one grid phase off/blown
green: yellow: red:		AC VOLTAGE TOO HIGH (alternating green & red LED)	AC Grid Voltage above UL limits (>228V if 208VAC, >528V if 480VAC)

green: 		feeding grid MPP or constant voltage mode	normal daytime operation
yellow: 			
red: 			
green: 		de-rating mode or inverter at full power	reduction of power fed to the grid due to increased temperature of the heatsink or inverter is at full rated power
yellow: 			
red: 			
green: 		GFDI fuse failure	GFDI fuse is defective see chapter 5
yellow: 			
red: 			
green: 		Contactor Failure (one blink)	Contactor timer run out before successful open or close
yellow: 			
red: 			
green: 		Vsense Failure (two blinks)	DSP board cannot communicate with vsense board
yellow: 			
red: 			
green: 		Thermal Overshot (three blinks)	Contactor open during power operation because of thermal overshoot
yellow: 			
red: 			
green: 		Current Sensor Failure (Four blinks)	Current sensor failed self-calibration during the unit wakeup
yellow: 			
red: 			
green: 		Temperature Sensor Failure (five blinks)	Temperature sensor read below -30C
yellow: 			
red: 			
green: 		Desat Failure (one blink (pause) two blinks)	Power stage desaturation failure
yellow: 			
red: 			
green: 		IGBT over temperature (one blink (pause) three blinks)	Power stage junction temperature over limit (125C)
yellow: 			
red: 			
green: 		Utility Failure	A failure of the Utility (i.e. a blackout or brownout) has occurred Unit will restart 5 min after grid (AC) restored
yellow: 			
red: 			
green: 		5 minute wait for re-start (alternating green, yellow & red LEDs in sequence)	Utility required 5 minute wait for restart in process since grid (AC) restored
yellow: 			
red: 			
green: 		Wong AC Phase Sequence	Switch two phase wires for correct clockwise sequence
yellow: 			
red: 			

4.2 LCD Display

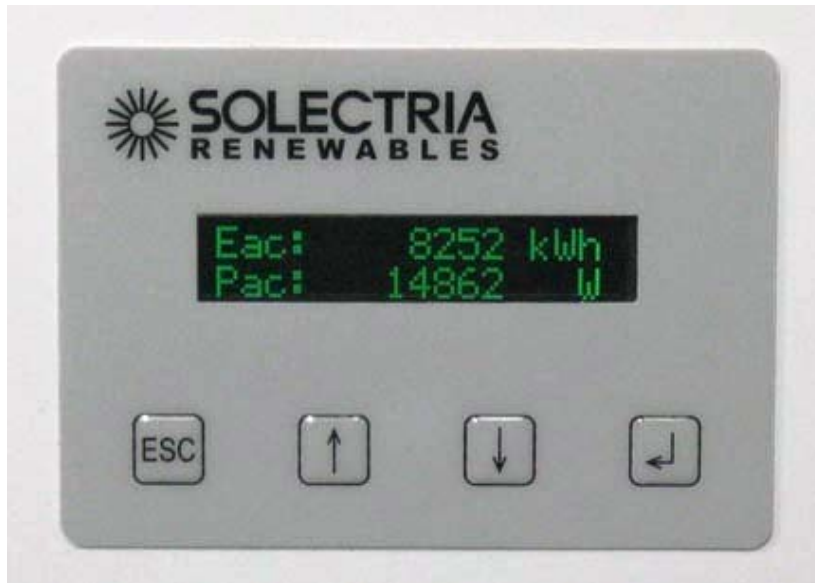

Button Description

ESC: To move up a level from the current menu.

↑↓: To scroll up/down the individual menu items

↵: To enter into selected menu.

Main/Default Screen

Eac: XXXX kWh
Pac: XX W

Press any of the following keys to move from the main/default screen into the Start Menu ↑↓↵

To enter into selected menu item, press the ↵ key.

Start Menu

1. Measurements
2. Set Inverter
3. Set Monitor
4. KYZ Meter
5. Display Info

Measurements Menu

This displays the data retrieved from the inverter. Use the ↑↓ buttons to move up and down the list:

- AC Energy
- AC Power
- AC Voltage
- AC Current (3 phase average)
- DC Voltage

Pressing ESC will take the screen back to the start menu.

Note: data will only be available when inverter is awake and communicating.

Set Inverter Menu

Displays inverter parameters, some of which may be modified with the keypad.

1. Inverter ID *Serial port address/ID of the inverter*
2. Baud Rate *Serial port baud rate (Currently not adjustable)*
3. Vac Very High *AC Voltage Critical High*
4. Vac High *AC Voltage High*
5. Vac Low *AC Voltage Low*
6. Vac Very Low *AC Voltage Critical Low*
7. Fac Low *AC Frequency Low*
8. Fac Very Low *AC Frequency Critical Low*
9. Fac High *AC Frequency High (Not adjustable)*

Note: data is only available when inverter is awake and communicating.

Monitor Menu

Displays monitor settings that may be modified with the keypad.

1. LAN *Local Area Network configuration, applicable only for SolrenView monitoring*
 1. DHCP Mode *See SolrenView manual on DHCP*
 2. Static/Fallback IP *If DHCP is turned on, this is then used as the fallback IP*
 3. Gateway IP *IP address of LAN's default gateway.*
 4. Netmask *Subnet mask*
2. Date/Time *Manual time set. This may be overwritten by scheduled NIST updates.*
3. Reboot *Reboots the monitor*
4. Remote SRV *This starts the transmit process necessary for SolrenView monitoring. Units that are ordered with SolrenView monitoring will have this field turned on. Caution: Enabling this field when SolrenView service has not been confirmed/authorized may result in unnecessary wear on the unit.*

5. Reset SRV

Settings are cleared to factory defaults. Caution: This will also clear Revenue-grade KYZ counters.

KYZ Meter Menu

Displays KYZ readings, if installed. See Solrenview manual for KYZ installation.

- | | |
|-----------------|---|
| 1. AC Energy | <i>Cumulative energy count</i> |
| 2. AC Power | <i>Power reading</i> |
| 3. Pulse Weight | <i>Multiplier to convert pulses to WH for display. F
For example Pulse Weight = 10 WH
→ 1 pulse = 10 WH</i> |

5 Troubleshooting and Maintenance

The Inverters are designed, produced and rigorously tested for long life and reliability in a wide range of climate conditions, voltage and power levels.

With a properly shipped, sited, mounted, wired and tested installation, the integrated inverter units should give many years of trouble-free service.

The following trouble shooting information will help in the event that the inverter does not function, stops functioning or does not provide full performance.



WARNING: Before attempting to open disconnects or the main enclosure, read the entire manual, especially warning messages and “Opening The Main Enclosure” later in this section. Only qualified personnel should attempt to open any of these enclosure doors or do any service or troubleshooting.

PV system not functioning

- Check LED indicator status and LCD display
- Check connection to grid, 3-phase AC power, clockwise phase rotation (with meter)
- Check DC (PV) string connections or main PV feed conductor connections
- Verify PV voltage range including hot module temperature MPP voltage and cold module temperature, open circuit voltage (OCV)
- Contact installer or Solectria Renewables if malfunction persists
- If contacting Solectria Renewables for assistance, please provide part number, serial number, short description of problem (LED indicator status, when problem started, how often problem occurs, under what conditions the problem occurs) and information on PV modules (string layout, number of modules per string, number of strings, module model and part number, output power, short-circuit current and open circuit voltage)

Some specific problems that can be identified quickly

GFDI Problem: If the LED indicators show a ground fault problem but the GFDI fuse is not blown then a ground fault in PV array or wiring must be found. If the LED indicators show that the GFDI fuse is blown, the fault in PV array or wiring must be found and GFDI fuse replaced. For fuse replacement, see section 4 “Power, GFDI and Error LED Indicators”.

Inverter over-heating and power de-rating: If the power output is lower than normal and there is an LED indication of power de-rating due to high temperature, check the following

- Is the ambient air temp above 45-50°C?
- Is the intake (front) louver grill or output (bottom) visibly blocked?

Unit over heating, power de-rating, or unit not putting out power

- Check insect screens in front louver grill on main enclosure door for clogging from dust, pollen and debris. The louver/grill can be removed with 18 Philips screws holding it on and insect screen can be cleaned or replaced.
- Fan not running, blocked or slow
 - Check fan fuse inside main enclosure (10A) AC.
 - Check fan relay inside main enclosure.
 - Check the fan and make sure it spins freely (when unit turned off).
- No grid sensing
 - Grid sensing fuses blown (0.5A or as labeled) AC inside main enclosure. Contact Solectria Renewables (Do not replace fuses, as this represents an abnormal failure).
- No LED indications when sun is shining. If grid voltage and DC (PV) voltage is present and no response from inverter is evident
 - Verify AC & DC (PV) voltages are within proper ranges.
 - Verify fuses in AC & DC (PV) disconnect are good (if equipped with PV sub-combiner).

If at some point it is determined that the unit or any part of the unit should be shipped to Solectria Renewables for repair or replacement, be sure to get an RMA# from Solectria Renewables and use the same packing method as when it was shipped to you, or request instruction on packing and/or packing materials from Solectria Renewables to help insure a safe shipment. The 55 lb core inverter electronics unit is easy to remove and replace (65lb shipping weight incl. shipping box).

Intake Louver Vent Cleaning

With the unit off, DC disconnect off (to prevent needless ingestion of more dust), for example do early morning or late evening so little or no energy generation is lost.

Method 1: remove shroud by removing all Phil Pan #2 machine screws around shroud (sides and top), and remove shroud. Without removing vent, use a powerful vacuum and clean entire louver vent/screen.

Method 2: remove vent by removing all Phil Pan #2 machine screws around shroud (sides and top), and remove shroud. Next remove remaining bottom screws holding louver vent onto inverter. Use compressed air from the back (insect screen) side of the louver vent/screen unit to remove all debris. Re-assemble putting all screws in LOOSELY first and then tighten snug (do not over-tighten).

Opening the Main Enclosure

Normally the main enclosure (or disconnects) will not have to be opened for any reason by the user. If opening the unit is necessary follow these guidelines:



WARNING: The inverter should only be opened up by authorized and qualified service personnel.



WARNING: Only open the inverter when it is clear and dry outside if the inverter is outdoors. As with any electrical system do not work on it if there is a potential of an electrical storm.



WARNING: Both DC and AC disconnects must be in the off position and wait 60 seconds after the LED indicators are off before opening as electrolytic capacitors on the internal DC “bus” are discharging during this time.

- Switch off DC disconnect
- Switch off AC disconnect (and AC building panel circuit breaker)
- Watch until all LED indicators have been off for 60 seconds (if not already off)
- Open handle on door (use key if locked)

See Fig. 8 and “Inside the Main Enclosure You Will See” section that follows.

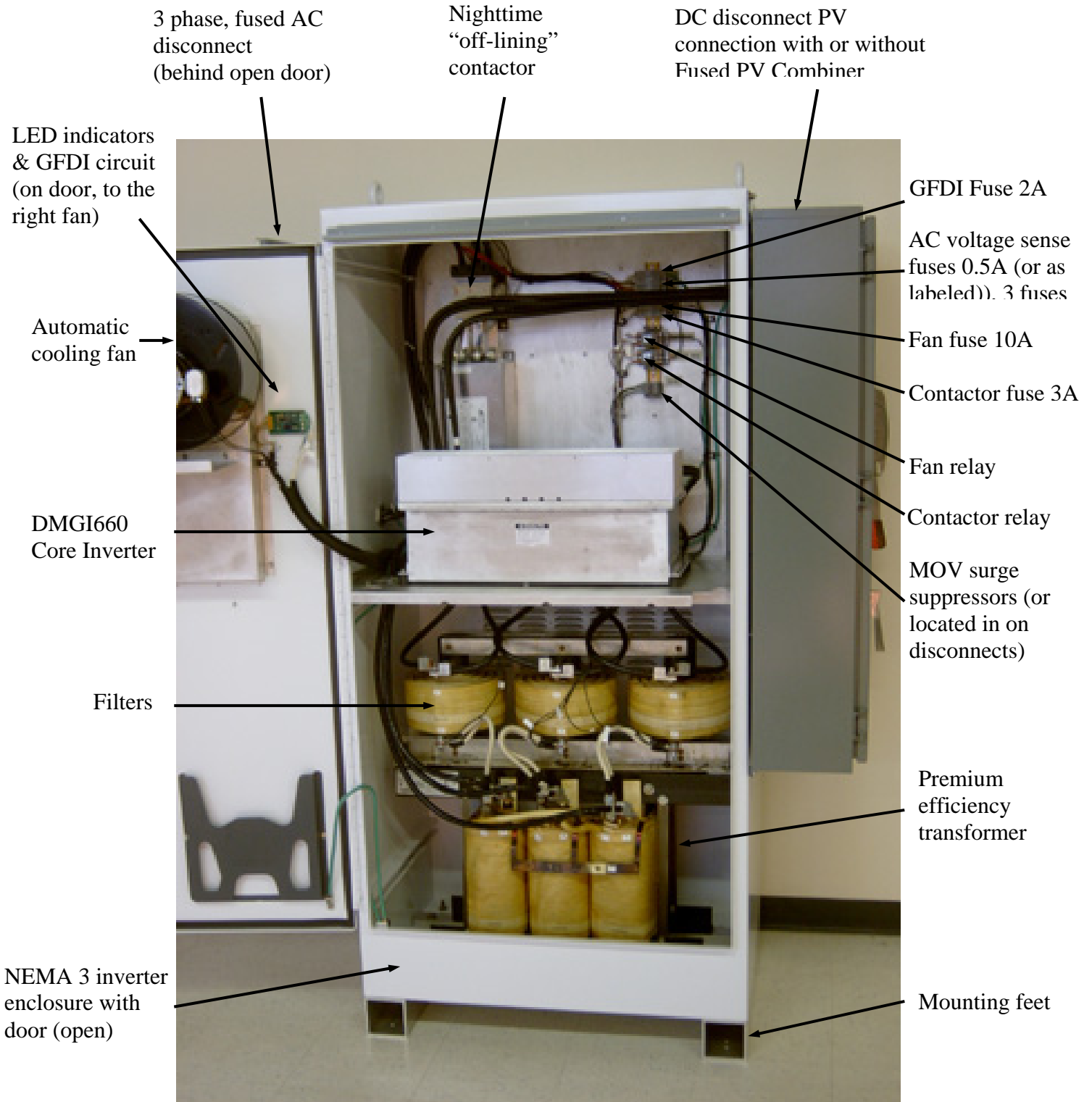

Fig. 8 Description and location of components

Inside the Main Enclosure you will see:

- DMGI660 Controller and power electronics inverter module with fan
- Isolation transformer
- Filters
 - 3 Round Torroids
 - 1 Rectangular Filter
- Night-time 3-phase off-lining contactor
- Fuse blocks
 - GFDI 2A DC fuse KLKD, 600 VDC rated
 - Grid Sense Phase A, 0.5 A (or as labeled) AC Fuse (L1), KLM, 500 VAC rated
 - Grid Sense Phase B, 0.5 A (or as labeled) AC Fuse (L2), KLM, 500 VAC rated
 - Grid Sense Phase C, 0.5 A (or as labeled) AC Fuse (L3), KLM, 500 VAC rated
 - Fan 10 A, AC Fuse, KLM, 500 VAC rated
 - Contactor 3 A, AC Fuse, KLM, 500 VAC rated
- Fan Control Relay
- Contactor Control Relay
- GFDI/LED Indicator PCB

Before closing the main enclosure always check for any signs of problems such as corrosion, loose parts, insect or animal infestation, excessive dirt/dust or over heated or deformed/aged-looking parts. Also be sure if any wires were moved or cable ties cut, that they are replaced as new.

To Open the DC Disconnect:

To open DC disconnect while off: (note that certain terminals are live inside even when off)
Turn the Bottom release screw counter clockwise and the aluminum handle will flip to the right (counter-clockwise). You can now open the door using the aluminum handle.

To open DC disconnect while on: (note that ALL terminals are live when on)
Turn the Bottom release screw counter clockwise and the aluminum handle will flip to the right (counter-clockwise). Next, turn the upper screw counter-clockwise while pulling the door open with the aluminum handle and the door should open.

You can spin the aluminum handle around in the counter-clockwise direction and it goes "click, click, click" as it turns. Nothing is broken in this case. Just keep turning the handle until it is at the 4:00 position when the door is open (or 6:00 position when door is closed.)

6 Product Warranty & RMA Policy

6.1 Warranty Policy

The Solectria Renewables Warranty Policy is stated below.

Solectria Renewables Warranty Coverage:

Solectria Renewables Limited Warranties are provided by Solectria Renewables, LLC. ("Solectria Renewables") and cover defects in workmanship and materials.

If equipped with optional Fat Spaniel hardware, Fat Spaniel hardware is not covered under the Solectria Renewables warranty but is covered by Fat Spaniel's 5-year warranty. Extended warranties covering Solectria Renewables inverters do not cover Fat Spaniel hardware.

Duration of a Solectria Renewables Warranty Period:

The warranty period is 60 months from the date of purchase of the PVI 60KW / PVI 82KW / PVI 95KW by the end user or 64 months after the delivery date from Solectria Renewables to distributor or dealer/installer, whichever is shorter. If a warranty extension has been purchased, the term is defined as extension beyond 60 months. For example, if a 5-year extension (to 10 years total) is purchased, the term becomes 120 months from date of purchase.

If Solectria Renewables repairs or replaces a product, its warranty continues for the remaining portion of the original Warranty Period or 90 days from the date of the return shipment to the customer, whichever is greater.

All warranties are null and void if full payment for products and associated shipping are not received in full and in a timely manner by Solectria Renewables.

Please contact Solectria Renewables Customer Service for further details on other products.

What will Solectria Renewables do?

Solectria Renewables will, at its option, repair or replace the defective product free of charge, provided that you notify Solectria Renewables of the product defect within the Warranty Period for your product, and provided that Solectria Renewables, through inspection, establishes the existence of such a defect and that it is covered by the Limited Warranty.

Solectria Renewables will, at its option, use new and/or reconditioned parts in performing warranty repair and building replacement products. Solectria Renewables reserves the right to use parts or products of original or improved design in the repair or replacement. All replaced products and all parts removed from repaired products become the property of Solectria Renewables.

Solectria Renewables will attempt to repair the unit within a reasonable time period (there is no reimbursement for lost energy production.)

Solectria Renewables covers both parts and labor necessary to repair the product, and return

shipment to the customer via a Solectria Renewables-selected non-expedited surface freight within the contiguous United States and Canada. Alaska and Hawaii the Rest of the World are excluded. Contact Solectria Renewables customer service for details on freight policy for return shipments outside of the contiguous United States and Canada.

In the event an extended warranty option has been purchased, this extended warranty only applies to exposed outdoor locations (defined as rooftop or open/unprotected locations) if the product has been purchased to include the gasket-sealed AC and DC disconnect option or has a protective cover around 3 sides of inverter unit (back and sides) and over the top, 4"-60" away from back and top and 30"-96" from sides.

Obtaining Service:

If your product requires troubleshooting or warranty service, contact your distributor or dealer/installer. If you are unable to contact your distributor or dealer/installer, or the distributor or dealer/installer is unable to provide service, contact Solectria Renewables directly at the number listed on the website in the customer service section for your product.

Solectria Renewables may send personnel to a jobsite or contract with an area technician, installer or other authorized, trained service personnel to service/replace components.

Reimbursement for contracted services: Solectria Renewables will submit a purchase order to the designated service personnel before work is performed. This purchase order will cover time expected for the required service and most likely an allocation for travel time.

Direct returns may be performed according to the Solectria Renewables Return Material Authorization Policy.

In any warranty claim, dated proof of purchase must accompany the product and the product must not have been disassembled or modified without prior written authorization by Solectria Renewables.

Proof of purchase may be in any one of the following forms:

- The dated purchase receipt from the original purchase of the product at point of sale to the end user, or
- The dated distributor or dealer/installer invoice or purchase receipt showing original equipment manufacturer (OEM) status, or
- The dated invoice or purchase receipt showing the product exchanged under warranty.

Solectria Renewables provides trouble-shooting service Monday-Friday, 9am-6pm EST. Once a problem is identified, necessary replacement component(s) will be dispatched within 1-2 days to the jobsite or the designated service personnel's address or will be brought to the site by Solectria Renewables' personnel.

What does the Solectria Renewables warranty not cover?

Solectria Renewables Limited Warranties do not cover normal wear and tear of the product or costs related to the removal, installation, or troubleshooting of the customer's electrical systems. These warranties do not apply to and Solectria Renewables will not be responsible for any defect in or damage to:

- a) The product, if it has been misused, neglected, improperly installed, physically damaged or altered, either internally or externally, or damaged from improper use or use in an unsuitable environment;
- b) The product, if it has been subjected to fire, water, generalized corrosion, biological infestations, acts of God or input voltage that creates operating conditions beyond the maximum or minimum limits listed in the Solectria Renewables product specifications including high input voltage from generators and lightning strikes;
- c) The product, if repairs have been done to it other than by Solectria Renewables or authorized, trained service personnel;
- d) The product, if it is used as a component part of a product expressly warranted by another manufacturer;
- e) The product, if its original identification (trademark, serial number) markings have been defaced, altered, or removed;
- f) The product, if it has been damaged in shipping (unless approved in writing by Solectria Renewables);
- g) Any installation and operation beyond the scope covered by relevant safety regulations (UL1741, NEC, etc.);
- h) Fat Spaniel hardware, if option has been purchased, is not covered under the Solectria Renewables warranty but is covered by Fat Spaniel's 5-year warranty. Extended warranties covering Solectria Renewables inverters do not cover Fat Spaniel hardware.

DISCLAIMER

SOLECTRIA RENEWABLES LIMITED WARRANTIES ARE THE SOLE AND EXCLUSIVE WARRANTY PROVIDED BY SOLECTRIA RENEWABLES IN CONNECTION WITH YOUR SOLECTRIA RENEWABLES PRODUCT AND ARE, WHERE PERMITTED BY LAW, IN LIEU OF ALL OTHER WARRANTIES, CONDITIONS, GUARANTEES, REPRESENTATIONS, OBLIGATIONS AND LIABILITIES, EXPRESS OR IMPLIED, STATUTORY OR OTHERWISE IN CONNECTION WITH THE PRODUCT, HOWEVER ARISING (WHETHER BY CONTRACT, TORT, NEGLIGENCE, PRINCIPLES OF MANUFACTURER'S LIABILITY, OPERATION OF LAW, CONDUCT, STATEMENT OR OTHERWISE), INCLUDING WITHOUT RESTRICTION ANY IMPLIED WARRANTY OR CONDITION OF QUALITY, DISTRIBUTOR OR DEALER/INSTALLER ABILITY OR FITNESS FOR A PARTICULAR PURPOSE. ANY IMPLIED WARRANTY OF DISTRIBUTOR OR DEALER/INSTALLER ABILITY OR FITNESS FOR A PARTICULAR PURPOSE TO THE EXTENT REQUIRED UNDER APPLICABLE LAW TO APPLY TO THE PRODUCT SHALL BE LIMITED IN DURATION TO THE PERIOD STIPULATED UNDER THIS LIMITED WARRANTY.

IN NO EVENT WILL SOLECTRIA RENEWABLES, LLC, INCLUDING ITS SUPPLIERS, MANUFACTURERS, VENDORS, SUBCONTRACTORS, DISTRIBUTORS, DEALERS AND ANY OTHER AFFILIATES BE LIABLE FOR ANY SPECIAL, DIRECT, INDIRECT, INCIDENTAL OR CONSEQUENTIAL DAMAGES, LOSSES, COSTS OR EXPENSES HOWEVER ARISING WHETHER IN CONTRACT OR TORT INCLUDING WITHOUT RESTRICTION ANY ECONOMIC LOSSES OF ANY KIND, ANY LOSS OR DAMAGE TO PROPERTY, ANY PERSONAL INJURY, ANY DAMAGE OR INJURY ARISING FROM OR AS A RESULT OF ANY USE, MISUSE OR ABUSE, OR THE (IN-) CORRECT INSTALLATION, INTEGRATION OR OPERATION OF THE PRODUCT.

Solectria Renewables neither assumes nor authorizes any other person to assume for it any other liability in connection with the repair or replacement or the Product.

Exclusions of the Policy:

If your product is a consumer product, federal law does not allow an exclusion of implied warranties. To the extent you are entitled to implied warranties under federal law, to the extent permitted by applicable law they are limited to the duration of this Limited Warranty. Some states and provinces do not allow limitations or exclusions on implied warranties or on the duration of an implied warranty or on the limitation or exclusion of incidental or consequential damages, so the above limitation(s) or exclusion(s) may not apply to you. This Limited Warranty gives you specific legal rights. You may have other rights, which may vary from state to state or province to province.

WITHOUT LIMITING THE GENERALITY OF THE FOREGOING, UNLESS SPECIFICALLY AGREED TO BY IT IN WRITING, SOLECTRIA RENEWABLES

(a) MAKES NO WARRANTY AS TO THE ACCURACY, SUFFICIENCY OR SUITABILITY OF ANY TECHNICAL OR OTHER INFORMATION PROVIDED IN MANUALS OR OTHER DOCUMENTATION PROVIDED BY IT IN CONNECTION WITH THE PRODUCT; AND

(b) ASSUMES NO RESPONSIBILITY OR LIABILITY FOR LOSSES, DAMAGES, COSTS OR EXPENSES, WHETHER SPECIAL, DIRECT, INDIRECT, CONSEQUENTIAL OR INCIDENTAL, WHICH MIGHT ARISE OUT OF THE USE OF SUCH INFORMATION.

THE USE OF ANY SUCH INFORMATION WILL BE ENTIRELY AT THE USER'S RISK.

WARNING: LIMITATIONS ON USE

Please refer to your product user manual for limitations on uses of the product. Specifically, please note that Solectria Renewables products are not intended for use in connection with life support systems and Solectria Renewables makes no warranty or representation in connection with any use of the product for such purposes.

Please review our Return Merchandise Authorization Policy for returning product to Solectria Renewables.

6.2 Return Material Authorization Policy

Please review our Return Merchandise Authorization Policy below after reviewing our Solectria Renewables Warranty Policy.

Obtaining a required, Return Material Authorization:

Before returning a product directly to Solectria Renewables you must obtain a Return Material Authorization (RMA) number and the correct factory "Ship To" address. Products must also be shipped prepaid. Product shipments will be refused and returned at your expense if they are

unauthorized, returned without an RMA number clearly marked on the outside of the shipping box, if they are shipped collect, or if they are shipped to the wrong location.

Information Solectria Renewables needs when you are obtaining service:

- 1) The model names and serial number of your product
- 2) Information about the installation and use of the unit
- 3) Information about the failure and/or reason for the return
- 4) A copy of your dated proof of purchase.

Preparing the product for shipping:

- 1) Package the unit safely, preferably using the original box and packing materials. Please ensure that your product is shipped fully insured in the original packaging or equivalent. This warranty will not apply where the product is damaged due to improper packaging.
- 2) Include the following:
 - a. The RMA number supplied by Solectria Renewables, LLC clearly marked on the outside of the box
 - b. A return address to which the unit can be shipped. Post office boxes are not acceptable.
 - c. A contact telephone number where you can be reached during work hours.
 - d. A brief description of the problem.

Ship the unit prepaid to the address provided by your Solectria Renewables customer service representative.

Returning a product from outside of the USA or Canada:

In addition to the above, you **MUST** include return freight funds and are fully responsible for all documents, duties, tariffs, and deposits.

7 Technical Data

Technical Information and specifications – see appendix for complete PVI 60KW, PVI 82KW AND PVI 95KW data sheet

Input (DC) from PV array:

- Maximum open circuit voltage of PV array: 600V DC



WARNING: NEC 690-7 must be followed to calculate the maximum number of PV modules allowed for a maximum inverter open circuit voltage (OCV) of 600V DC in extreme cold temperatures for the installation location.

- See PV string sizing charts in Appendix B



The open circuit voltage of PV modules depends on the cell temperature and the solar irradiation. The highest open circuit voltage occurs when the PV modules are at the coldest temperature and in bright sun. (See the following figure – Fig. 9)

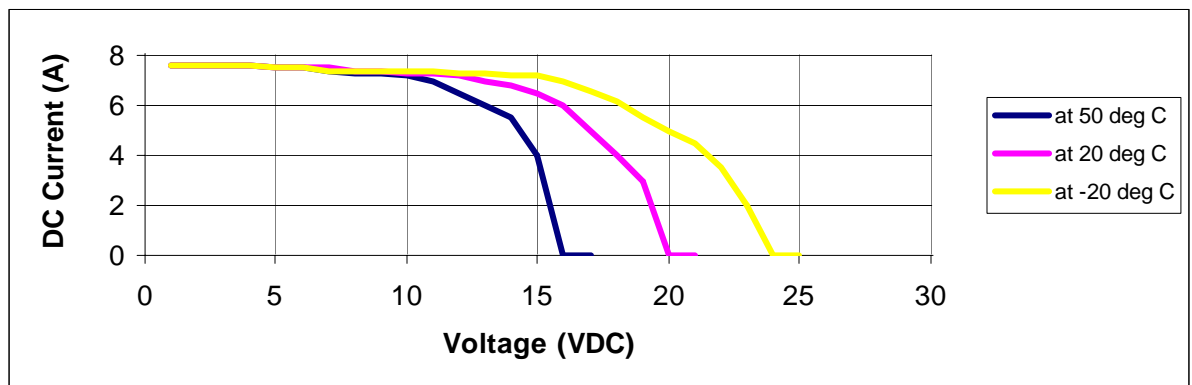

Fig. 9 Example representative PV module voltage – current characteristic at various cell temperatures

Because the PV modules also have a reduction in voltage at high cell temperatures, you must make sure the MPP voltage of the strings will not drop below the minimum inverter DC input voltage of 325V DC in very hot temperature conditions.

Both the maximum open circuit voltage (OCV) when at cold extreme and minimum MPP voltage when at hot extreme can be calculated for a PV module using its specification sheet. PV module string sizing can then be used to determine how many modules can/should be used in a string.

Input DC (PV) specifications for PVI 60KW, PVI 82KW AND PVI 95KW inverters

Inverter Model	PVI 60KW	PVI 82KW	PVI 95KW	
Operating voltage range (power)	325-550	325-550	325-550	VDC
Input voltage MPP range	330-500	330-500	330-500	VDC
Max continuous power range	340-480	340-480	340-480	VDC
Maximum open circuit voltage	600	600	600	VDC
Absolute Maximum open circuit voltage	620	620	620	VDC
Maximum input current				
208 and 480VAC versions	190	244	285	ADC
CEC eligible max. input current				
208VAC version	190	247	285	ADC
480VAC version	190	260	285	ADC
Maximum continuous input power (inverter limited)	63	87	100	kW DC
Maximum recommended PV power (modules @ STC)	50-70	70-90	80-115	kW DC
DC disconnect for PV positive (+)	included	included	included	
Ground fault detection, must detect	2	2	2	A
Ground fault interrupt	2	2	2	A

Output to AC grid connection:

The inverters are designed to feed power into a standard 60Hz, 3-phase 480V AC utility service or 480V AC provided within a facility by a transformer of not less than 150kVA. The 208VAC versions connect to a 208VAC service or facility transformer rated no less than 150kW. As required by NEC, there must be a dedicated 3-phase circuit breaker for the PV inverter connection. This circuit breaker or fusing (and wiring) must have a rating of the following:

100A minimum for the PVI 60KW-480VAC version (125A recommended)

125A minimum for the PVI 82KW-480VAC version

150A minimum for the PVI 95KW-480VAC version

250A required for the PVI 60KW-208VAC version*

300A required for the PVI 82KW-208VAC version*

350A required for the PVI 95KW-208VAC version*

* the current protection device must not exceed these values and should be this exact value.

Since fuses are included in the AC disconnect of the 480VAC inverter versions, the service and dedicated breaker can exceed the recommended minimums above as long as wiring is sized correctly and does not exceed the AC disconnects' maximum allowed wire size: 250KCMIL. The inverter is designed to work with the range of AC voltages for a 480VAC 3-phase service defined by UL1741 of 425V-528V. The 208VAC output version of the inverter has an AC voltage range of 190V to 228V.

Output (AC) specifications for PVI 60KW, PVI 82KW AND PVI 95KW Inverter:

Inverter Voltage		208	480	VAC
Nominal and Maximum output power (and CEC eligible output power)	PVI 60KW	60	60	kW AC
	PVI 82KW	83	83	kW AC
	PVI 95KW	95	95	kW AC
Operating voltage range		185 - 228	425 - 528	VAC
Operating voltage adjustability		50-120%		
Default over/under voltage trip points and times		per IEEE Std 1547-2003, Table 1		
Over / under voltage trip time adjustability		0.16 – 30		seconds
Voltage measurement accuracy		+/- 2 %		
Default Operating frequency range		59.8 - 60.5		Hz
Operating frequency adjustability		57.0 - 60.5		Hz
Default over / under frequency trip points and times		per IEEE Std. 1547-2003, Table 2		
Over / under frequency trip time adjustability		0.16 – 300		seconds
Frequency measurement accuracy		+/- 0.1		Hz
Maximum Output Current	PVI 60KW	166	73	A _{rms}
	PVI 82KW	229	100	A _{rms}
	PVI 95KW	261	115	A _{rms}
Peak short circuit output current		7	7	kA
Total Harmonic distortion (THD, @ full power)		< 5	< 5	%
Power Factor		98	98	%
Anti-islanding protection		per UL1741 / IEEE1547		
AC disconnect, 3-phase		included		
Over current protection		inverter limited		
Short circuit protection		per UL1741/IEEE1547		
Surge test		per UL1741/IEEE1547 and NY SIR		
Inverter peak Efficiency (50-75% load)* (complete integrated unit with transformer)		95.5	96.5	%
	CEC Weighted Efficiency (fan forced on 100% of the time)	94.5	95.5	%

Other specifications:

Ground fault protection 2005 NEC 690.5

PVI 60KW, PVI 82KW, PVI 95KW

DC sub-combiner-fuse enclosure
(Optional)

DC Disconnect (Integral)

Ambient Temperature

Storage Temperature

Cooling

Enclosure

Enclosure-electronics

Installation and Operation Manual

35A-200A fuses available
2-48 pole, NEMA 3R, TVSS

Break load rated, NEMA 3R

-25° to 50° C

-25° to 50° C

Forced Convection

rainproof per UL1741/IEEE1547

IP-62 (sealed design)

*Does not include MPP tracking and other transitory phenomena.

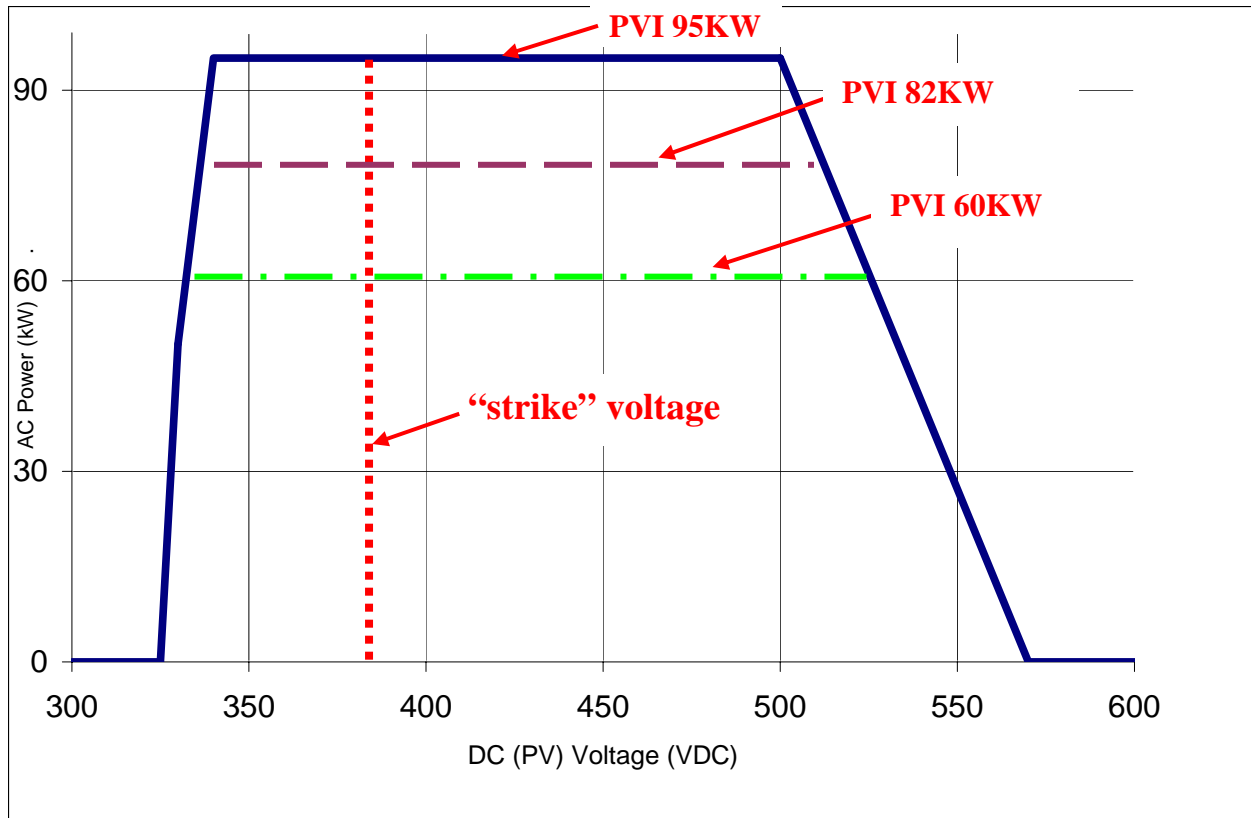

Fig. 10 AC Output power of PVI 60KW, PVI 82KW and PVI 95KW inverters

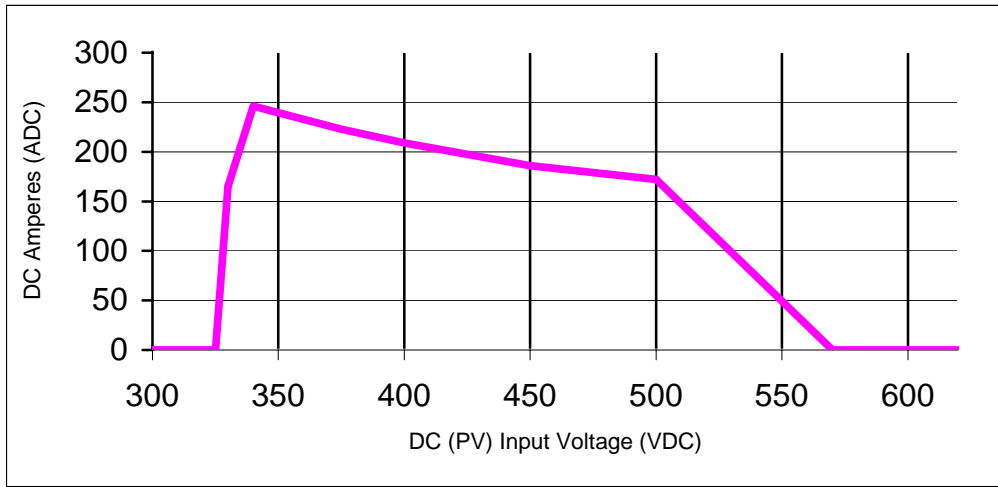

Fig. 11 Example maximum continuous DC current input for PVI 82KW

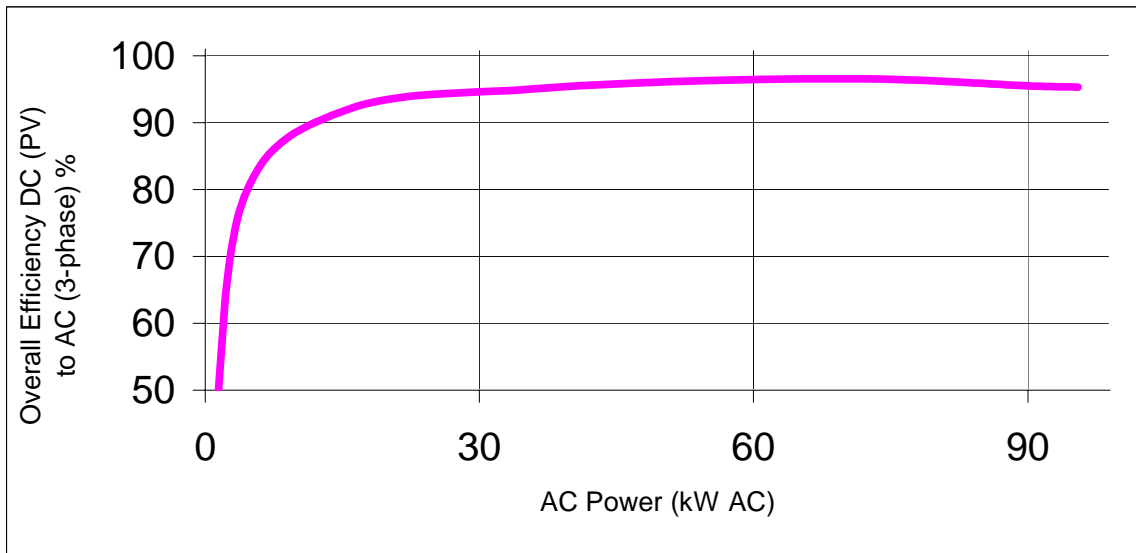
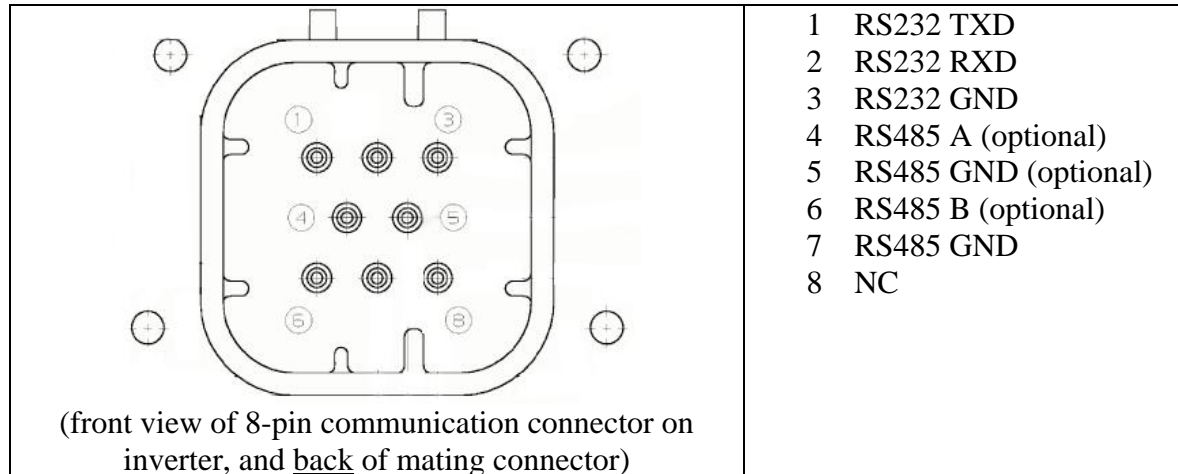

Fig. 12 PVI 95KW efficiency plot at 390VDC input and 25C ambient temperature (efficiency values were measured with a 3% accurate power meter setup and do not include any losses caused by long wires and transitory phenomena, i.e. MPP tracking)

Pin assignment RS232 / RS485 (optional)

Mating AMPSEAL 8-pin connector, Tyco part#: 776286-1
 AMSEAL crimp contact, Tyco part#: 770854-3

Warning:

RS232 and RS485 (standard on all inverters ordered after July 15, 2008) share the same serial port and only one can be used at one time! Both cannot be used at once. RS-485 must be ordered as an option and the inverter comes wired for 485 if it is ordered. The port can be toggled back and forth from 485 to 232 with PC software from the factory and a 232 serial cable.

When equipped with an optional RS485 communication interface, this inverter can be daisy-chained with any other residential or commercial Solectria Renewables' PV inverter for data logging. Each inverter needs to be set to a unique network ID.

Please call for information on data logging options / wiring diagrams. See Fat Spaniel manual if the inverter is equipped with Fat Spaniel Inverter Direct.

With the Optional RS-485 port, this connector comes in a harness pre-wired to DIN-rail mounted screw terminal blocks for easy access and connection to monitoring systems. Use "A" and "B" and connect from one inverter to another with "A" to "A" and "B" to "B". Ground is not currently used.

With Optional Fat Spaniel Inverter-Direct product and service, the Fat Spaniel Internet gateway is mounted directly above the RS-485 Din-rail terminal blocks and it is wired to the RS-485 port and tested. Use of the Fat Spaniel option required the RS-485 port. With SolrenView inverter-direct monitoring or revenue-grade with inverter-direct monitoring option, RS-485 is also used.

Appendix A – PVI 60KW, PVI 82KW and PVI 95KW Data Sheet

http://www.solren.com/downloads/PVI_60KW_PVI82KW_PVI95KW.pdf

Appendix B – Example PV string sizing chart(s)

Please See the website for detailed string sizing charts for many popular PV modules: www.solren.com Go to the Products page and the Photovoltaic inverters page.

Specific Link: http://www.solren.com/downloads/PVI_60KW_82KW_95KWString.pdf

Module Manufacturer	Isofon																		
Module Model	I-165																		
Power @ MPT	165.0 W																		
Voltage @ MPT (STC)	17.4 VDC																		
Current @ MPT (STC)	9.48 ADC																		
Current, short circuit	10.14 ADC																		
OCV @ 25 deg C cells	21.6 VDC																		
PTC Power Rating	148.1 W																		
Temp Coeff of Vmpt	0.063 V/degC (Vmpt)																		
Temp Coeff of Vocv	0.078 V/degC (Vocv)																		
NOCT (nom. cell temp)	47 deg C 116.6 deg F																		
For Vmpt @ max amb temp and OCV @ coldest temperature, green is OK, red is not OK																			
orange is acceptable but should be avoided where possible (inverter will hold at 330VDC).																			
purple is OK but indicates inverter will limit to 95 kW AC continuous output																			
pink is acceptable but should be avoided where possible (inverter will not run above 600VDC)																			
(note that NEC 690 prohibits system voltage to exceed 600VDC)																			
Modules total in array	352	396	484	550	594	660	368	414	506	575	598	667	384	432	528	576	600	672	
Modules per string	22	22	22	22	22	22	23	23	23	23	23	23	24	24	24	24	24	24	
Strings in Parallel	16	18	22	25	27	30	16	18	22	25	26	29	16	18	22	24	25	28	
Voltage @ MPT (STC)	382.8	382.8	382.8	382.8	382.8	382.8	400.2	400.2	400.2	400.2	400.2	400.2	417.6	417.6	417.6	417.6	417.6	417.6	
Vmpt @ max amb temp (30C, 86F amb)	338.4	338.4	338.4	338.4	338.4	338.4	353.8	353.8	353.8	353.8	353.8	353.8	369.2	369.2	369.2	369.2	369.2	369.2	
Vmpt @ max amb temp (35C, 95F amb)	331.5	331.5	331.5	331.5	331.5	331.5	346.6	346.6	346.6	346.6	346.6	346.6	361.7	361.7	361.7	361.7	361.7	361.7	
Vmpt @ max amb temp (40C, 104F amb)	324.6	324.6	324.6	324.6	324.6	324.6	339.3	339.3	339.3	339.3	339.3	339.3	354.1	354.1	354.1	354.1	354.1	354.1	
Vmpt @ max amb temp (45C, 113F amb)	317.7	317.7	317.7	317.7	317.7	317.7	332.1	332.1	332.1	332.1	332.1	332.1	346.5	346.5	346.5	346.5	346.5	346.5	
OCV @ 25 deg C cells	475.2	475.2	475.2	475.2	475.2	475.2	496.8	496.8	496.8	496.8	496.8	496.8	518.4	518.4	518.4	518.4	518.4	518.4	
OCV @ coldest temp (-40C, -40F amb)	586.7	586.7	586.7	586.7	586.7	586.7	613.4	613.4	613.4	613.4	613.4	613.4	640.1	640.1	640.1	640.1	640.1	640.1	
OCV @ coldest temp (-30C, -22F amb)	569.6	569.6	569.6	569.6	569.6	569.6	595.5	595.5	595.5	595.5	595.5	595.5	621.4	621.4	621.4	621.4	621.4	621.4	
OCV @ coldest temp (-20C, -4F amb)	552.4	552.4	552.4	552.4	552.4	552.4	577.5	577.5	577.5	577.5	577.5	577.5	602.6	602.6	602.6	602.6	602.6	602.6	
OCV @ coldest temp (-10C, 14F amb)	535.3	535.3	535.3	535.3	535.3	535.3	559.6	559.6	559.6	559.6	559.6	559.6	583.9	583.9	583.9	583.9	583.9	583.9	
OCV @ coldest temp (0C, 32F amb)	518.1	518.1	518.1	518.1	518.1	518.1	541.7	541.7	541.7	541.7	541.7	541.7	565.2	565.2	565.2	565.2	565.2	565.2	
Power @ MPT	58080	65340	79860	90750	98010	108900	60720	68310	83490	94875	98670	110055	63360	71280	87120	95040	99000	110880	
PTC ACsystem power rating	49785	56008	68455	77790	84013	93347	52048	58554	71566	81325	84578	94337	54311	61100	74678	81467	84861	95045	
Inverter Used	PVI 60KW PVI 60KW PVI 82KW PVI 82KW PVI 95KW PVI 95KW PVI 60KW PVI 60KW PVI 82KW PVI 82KW PVI 95KW PVI 95KW PVI 60KW PVI 60KW PVI 82KW PVI 82KW PVI 95KW PVI 95KW																		

Appendix C - Contact Information

Solectria Renewables LLC
360 Merrimack Street, Building 9
Lawrence, Massachusetts, 01843
USA

Tel: 978.683.9700

Fax: 978.683.9702

Email: inverters@solren.com

Website: www.solren.com

Authorized Distributors/Dealers/Installers/Designers:

See website for complete and updated listing: www.solren.com

Specific Link: <http://www.solren.com/contact/dist.htm>

Appendix D – UL1741 IEEE 1547 Authorization Letter to Mark Product:



August 8, 2007

Letter Report No. 3113125CRT-001c
Project No. 3113125

James Worden
Solectria Renewables, LLC
360 Merrimack Street
Lawrence, MA 01843 USA

Ph: (978) 683-9700
Fx: (978) 683-9702
email: James@solren.com

Subject: ETL testing of Solectria's PVI 60, 82 and 95 KW version of solar inverter

Dear Mr. Worden,

This letter confirms that Intertek Testing Services has completed our Safety evaluation of your PVI 60 KW, 82 KW (also known as 77KW) and 95 KW (also known as 90KW) solar inverters, and have listed the following products to the Standard *Inverters, Converters, Controllers and Interconnection System Equipment for Use with Distributed Energy Resources, UL 1741 First Edition, Dated May 7, 1999 - Revisions through and including November 7, 2005.*

As part of the listing noted above, Intertek confirmed by test that the products above conform to the surge test requirements specified in IEEE C62.41.2.

If you have any questions related to the status of this product, please do not hesitate to contact the undersigned.

Prepared by: Donald Osborne
Title: Project Engineer

Reviewed by: Steven Pasternack
Title: Sr. Staff Engineer

Signature: Donald Osborne
Date: 8/8/2007

Signature: Steven Pasternack
Date: 8/8/2007



An Independent Organization Testing for Safety and Performance

Page 1 of 1

This report is for the exclusive use of Intertek's Client and is provided pursuant to the agreement between Intertek and its Client. Intertek's responsibility and liability are limited to the terms and conditions of the agreement. Intertek assumes no liability to any party, other than to the Client in accordance with the agreement, for any loss, expense or damage occasioned by the use of this report. Only the Client is authorized to permit copying or distribution of this report and then only in its entirety. Any use of the Intertek name or one of its marks for the sale or advertisement of the tested material, product or service must first be approved in writing by Intertek. The observations and test results in this report are relevant only the sample tested. This report by itself does not imply that the material, product or service is or has ever been under an Intertek certification program.

Intertek Testing Services NA, Inc.
3933 US Route 11 Cortland, NY 13045
Telephone: 1-607-758-6711 Fax: 1-607-753-1045 Web: www.intertek-etlsemko.com
SD 12.1.2 (3/22/07) Informative